

## DualProof pre-applied waterproofing membrane Installation Guideline

DualProof T 1,2mm - pre-applied waterproofing membrane  
DualProof T 2,0mm - pre-applied waterproofing membrane

DualProof S 1,2mm - post-applied waterproofing membrane s - swelling, self-healing  
DualProof S 2,0mm - post-applied waterproofing membrane s - swelling, self-healing

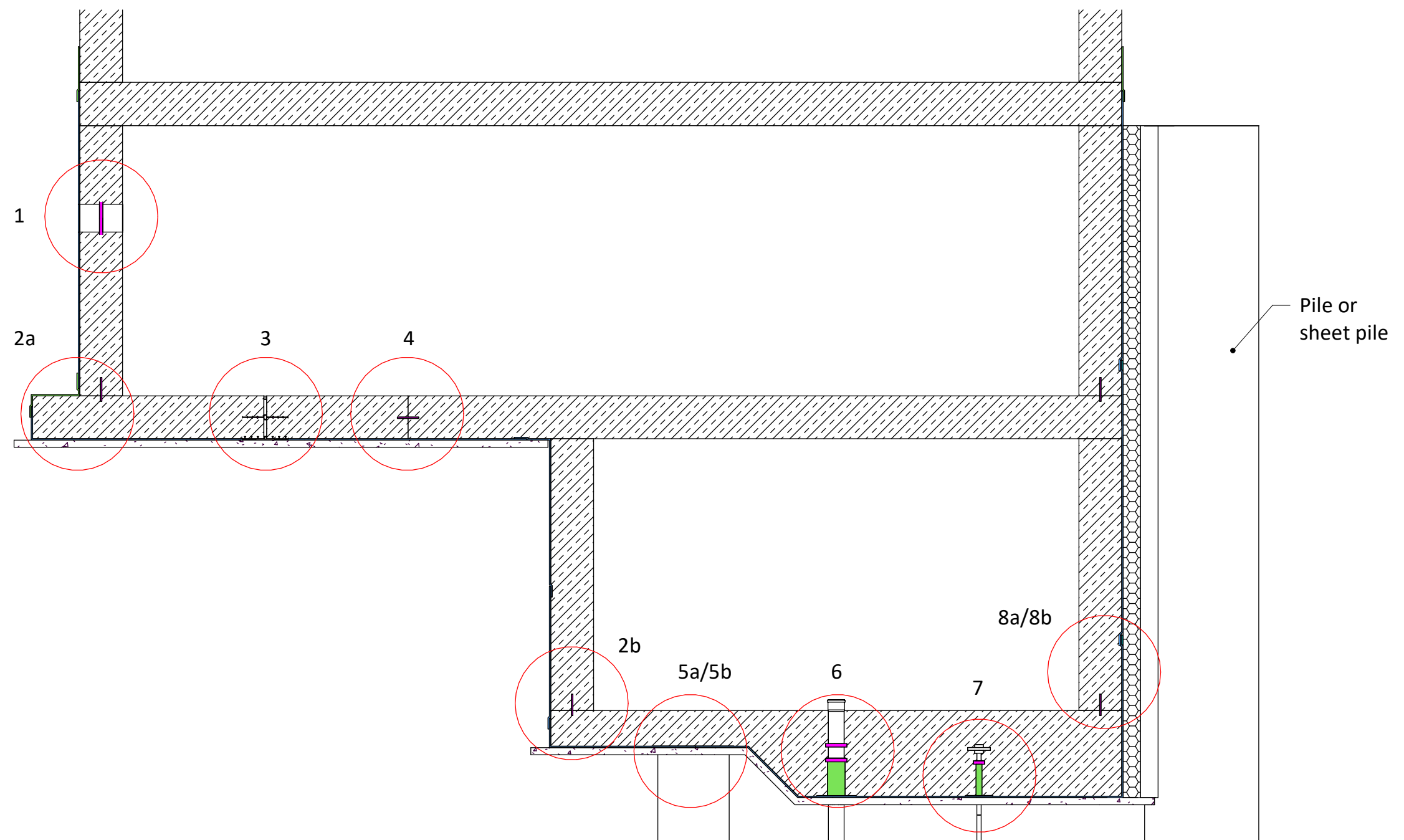

## DualProof pre-applied waterproofing membrane Installation Guidline

DualProof T 1,2mm - pre-applied waterproofing membrane  
DualProof T 2,0mm - pre-applied waterproofing membrane

DualProof S 1,2mm - post-applied waterproofing membrane s - swelling, self-healing  
DualProof S 2,0mm - post-applied waterproofing membrane s - swelling, self-healing

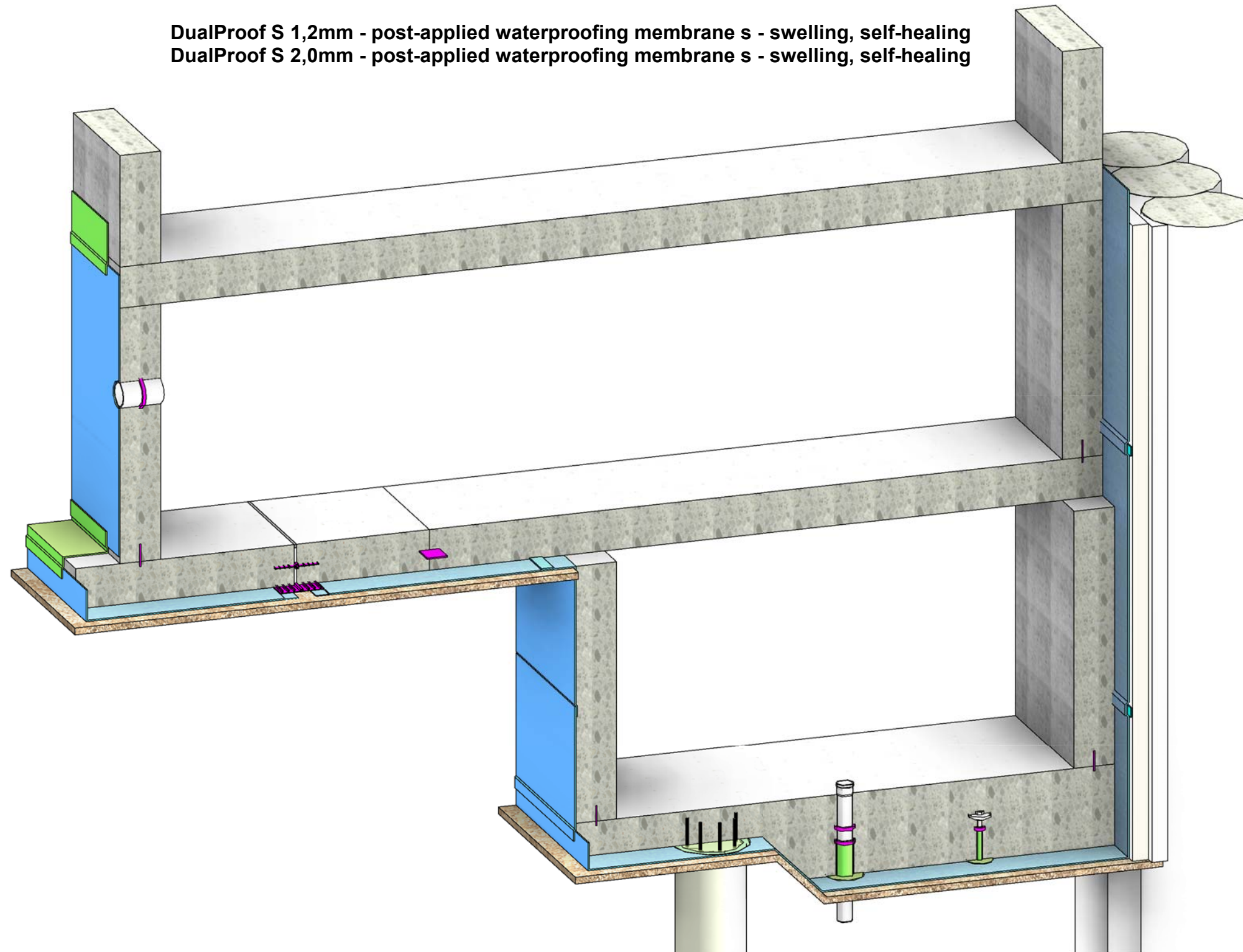

## DualProof pre-applied waterproofing membrane Installation Guidline

DualProof T 1,2mm - pre-applied waterproofing membrane  
DualProof T 2,0mm - pre-applied waterproofing membrane

DualProof S 1,2mm - post-applied waterproofing membrane s - swelling, self-healing  
DualProof S 2,0mm - post-applied waterproofing membrane s - swelling, self-healing

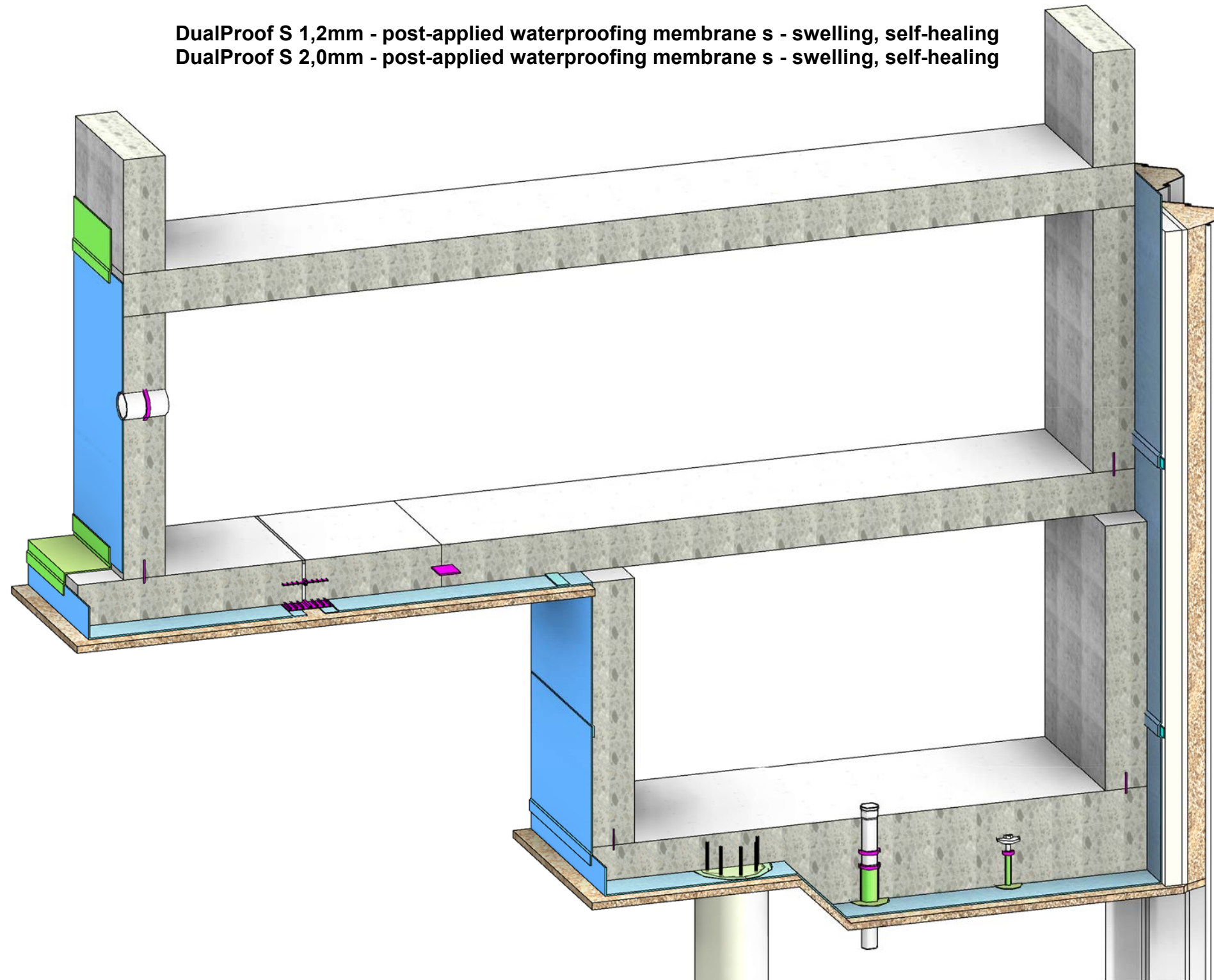

## 1 Pipe Penetration

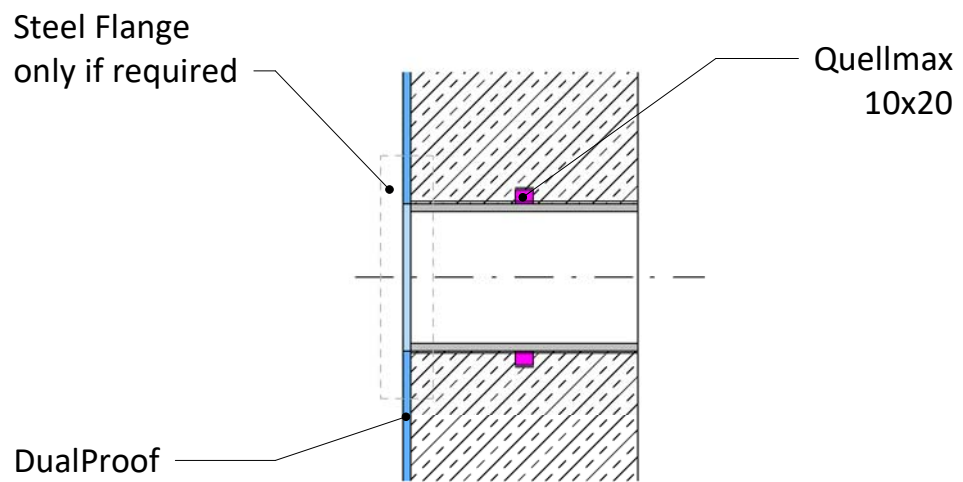
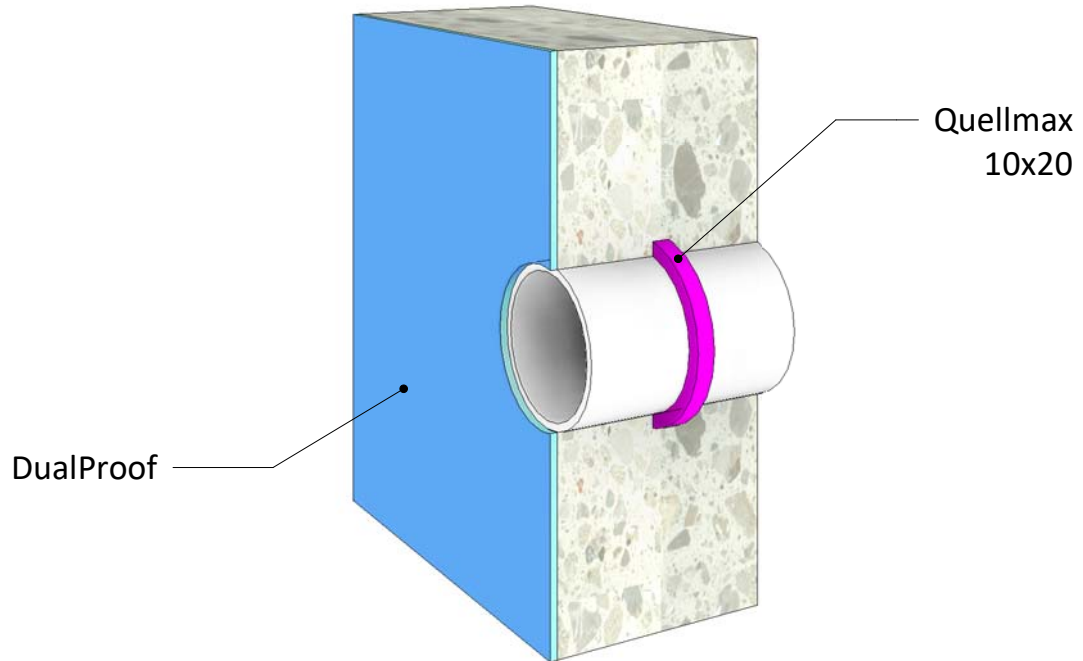

Project:

Title: 1 Pipe Penetration

Clients:

Date:

Drawing by TE

BPA © 02/2018

### 2a Floor Slab / wall

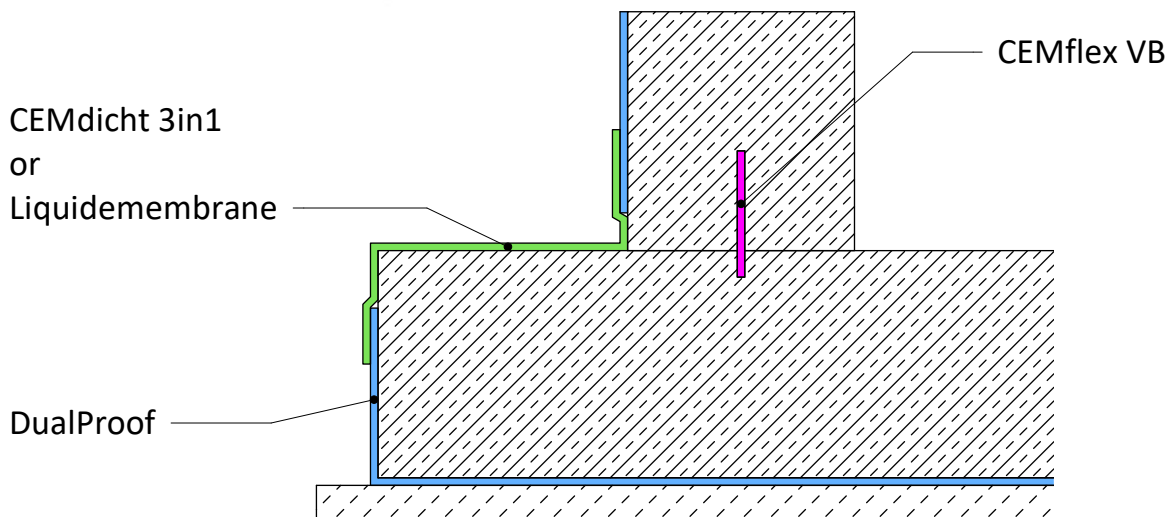
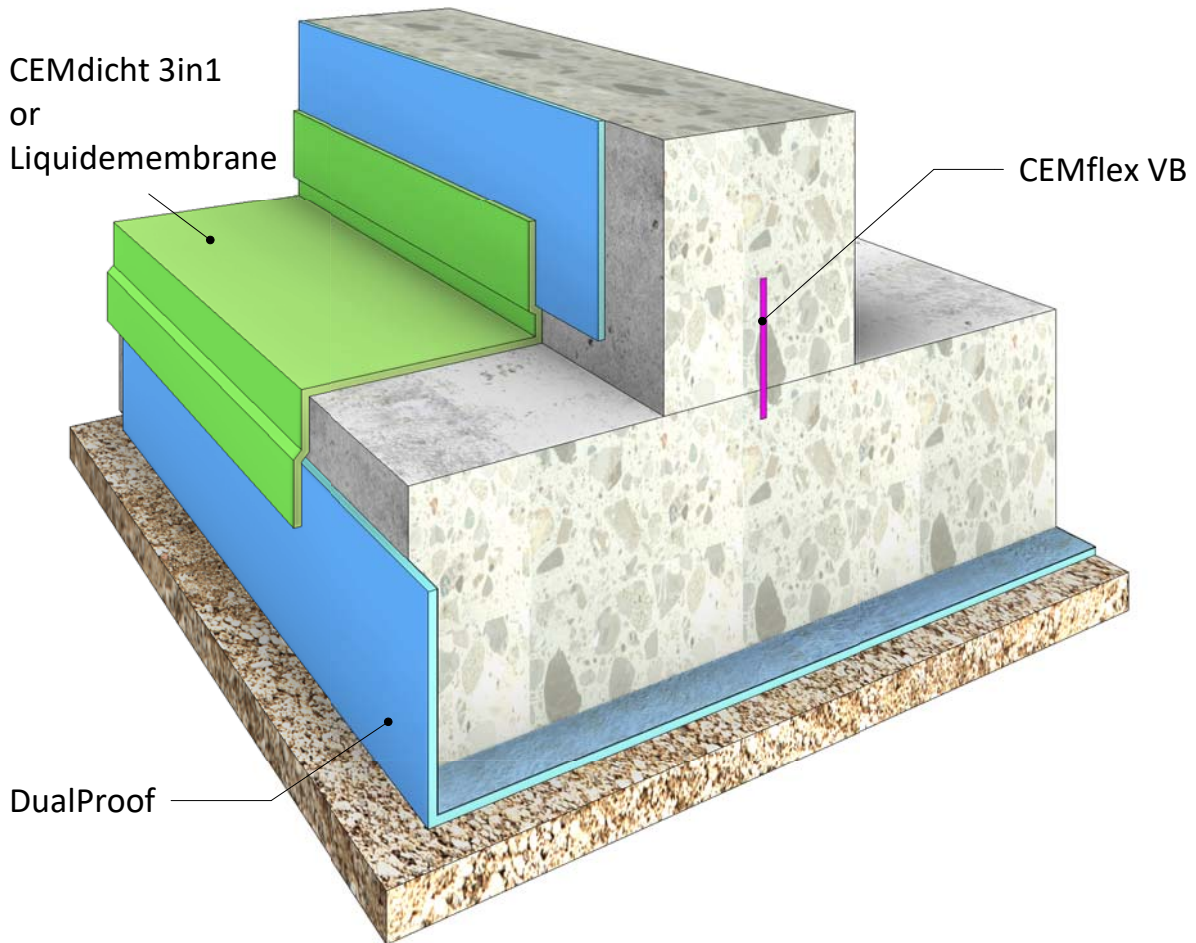

Project:

Title: 2a Floor Slab / wall

Clients:

Date:

Drawing by TE

BPA © 02/2018

### 2b Floor Slab / wall

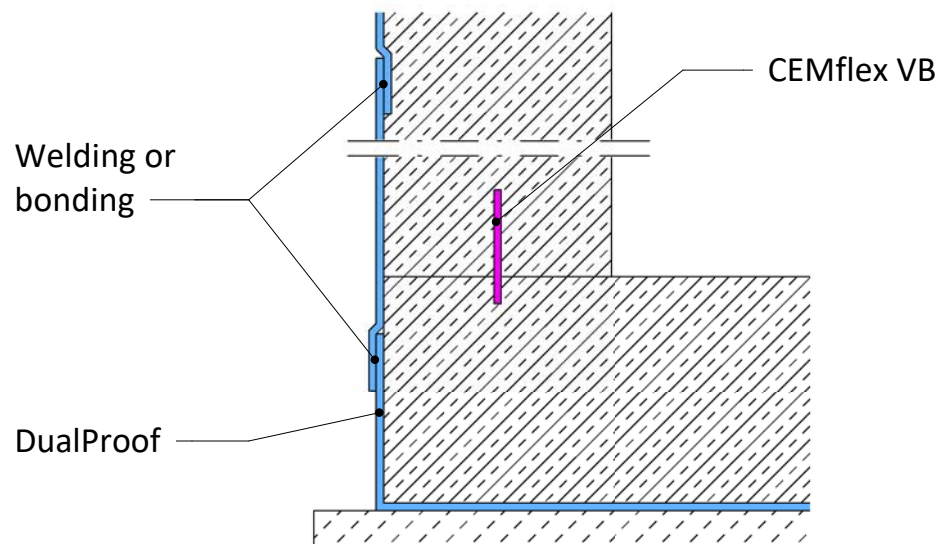
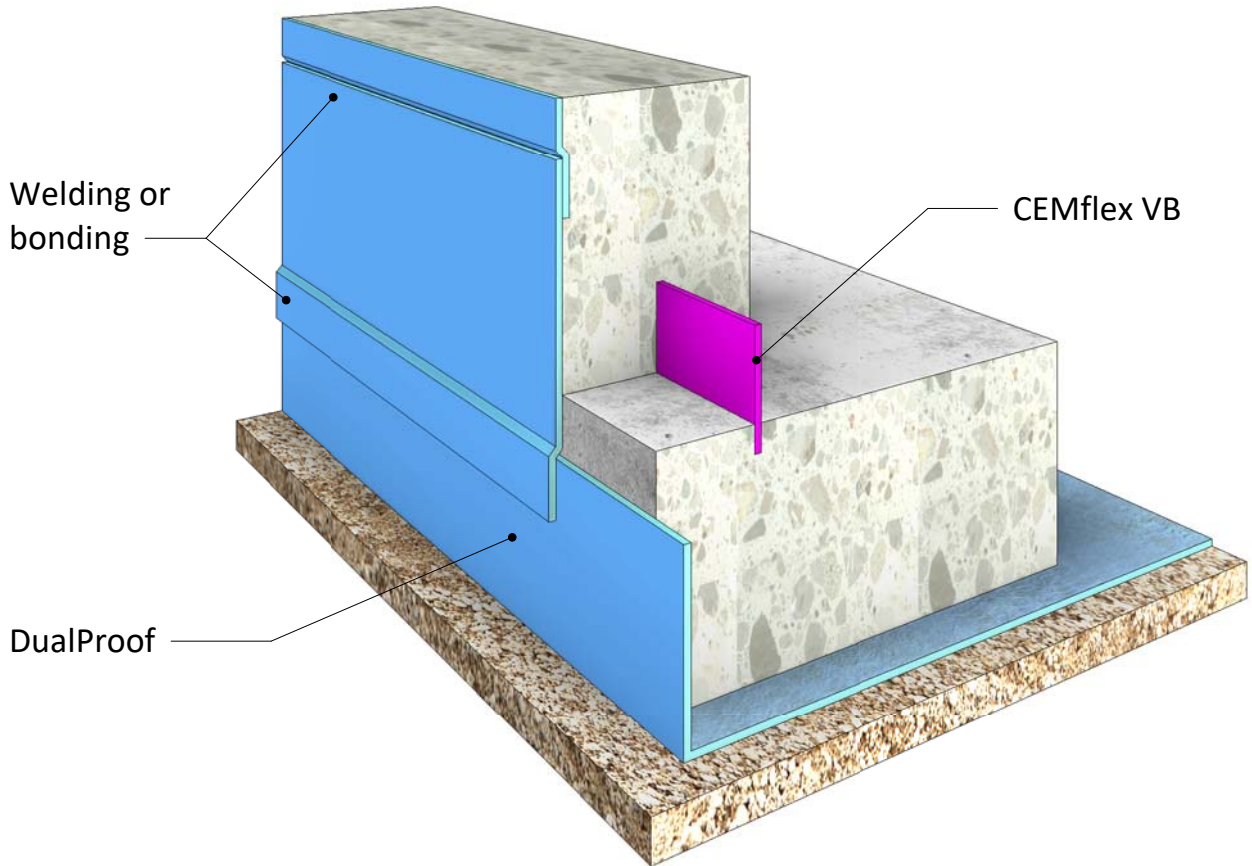

Project:

Title: 2b Floor Slab / wall

Clients:

Date:

Drawing by TE

BPA © 02/2018

## 4 Construction Joint horizontal

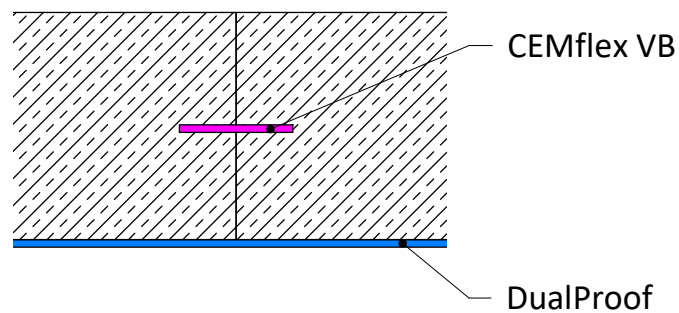
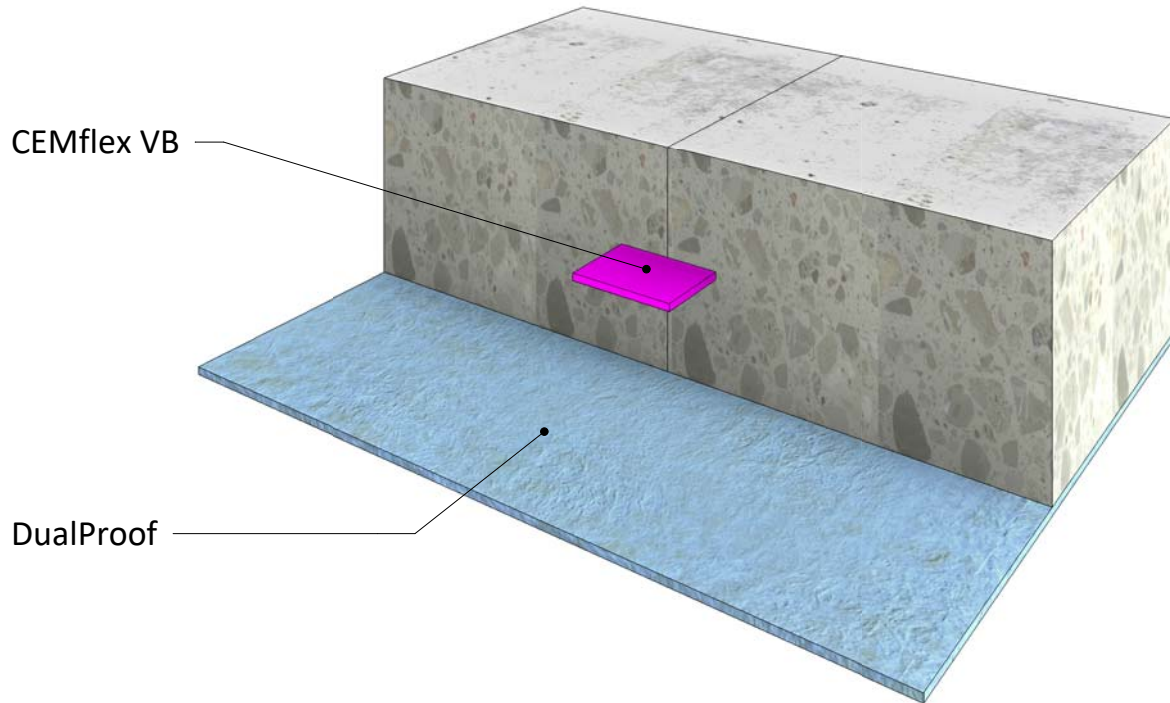

Project:

Title: **4 Construction Joint horizontal**

Clients:

Date:

Drawing by TE

BPA © 02/2018

## 5a Concrete Pile

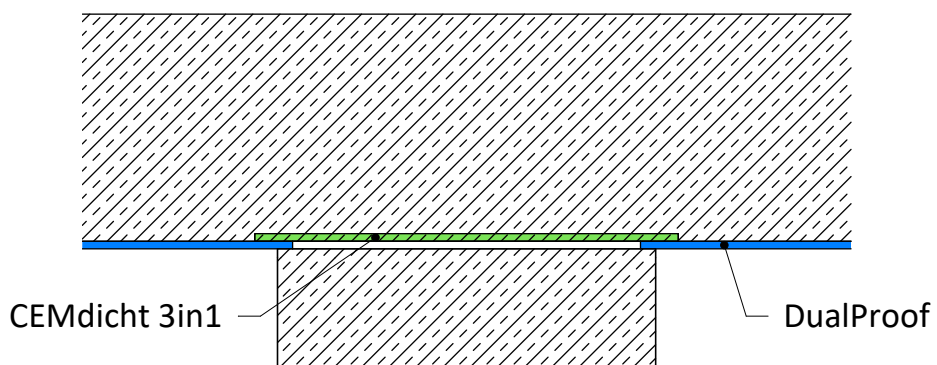
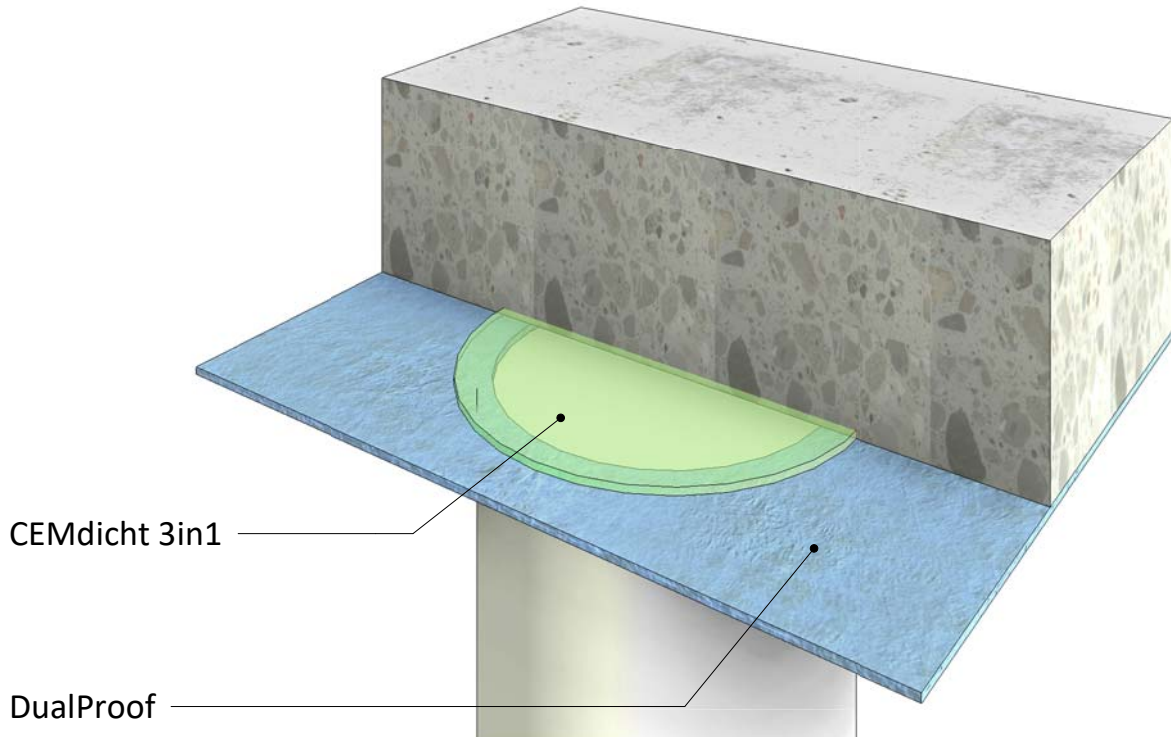

Project:

Title: **5a Concrete Pile**

Clients:

Date:

Drawing by TE

BPA © 02/2018



## 5b Concrete Pile

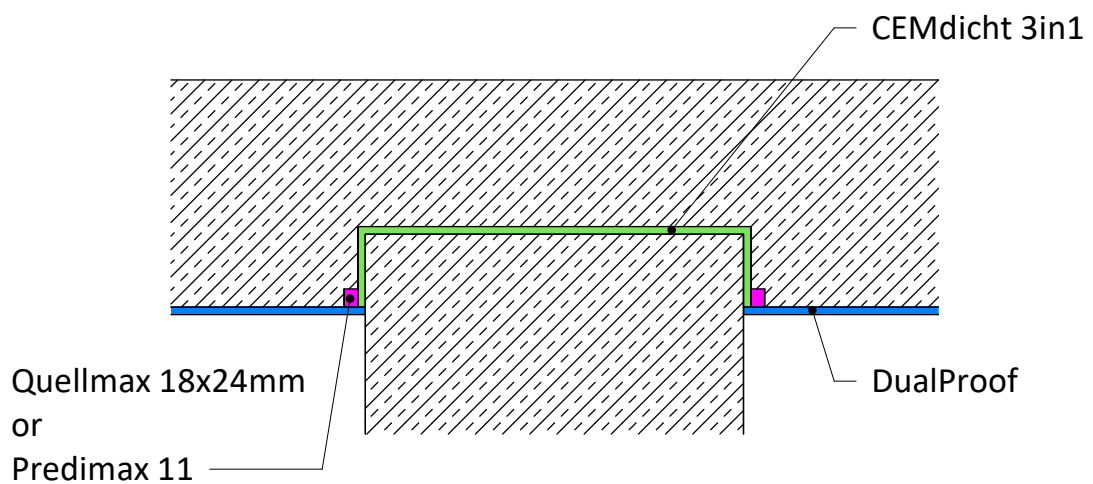
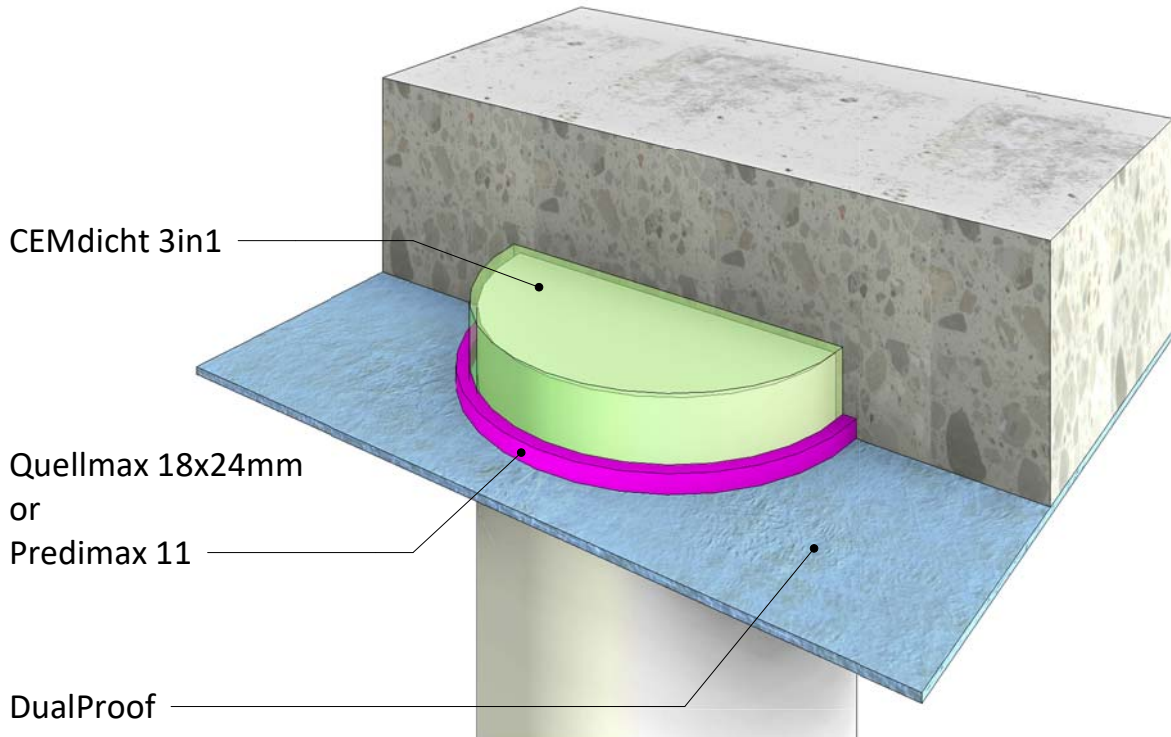

Project:

Title: **5b Concrete Pile**

Clients:

Date:

Drawing by TE

BPA © 02/2018

## 6 Pipe Penetration Floor Slab

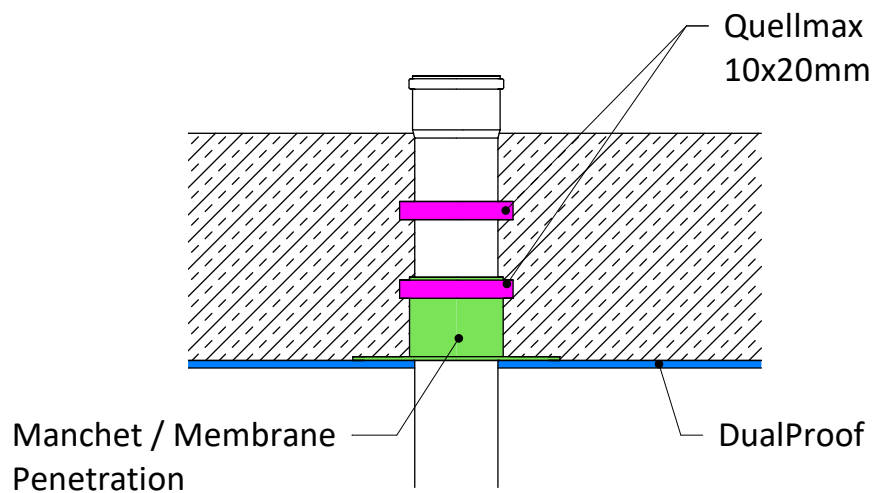
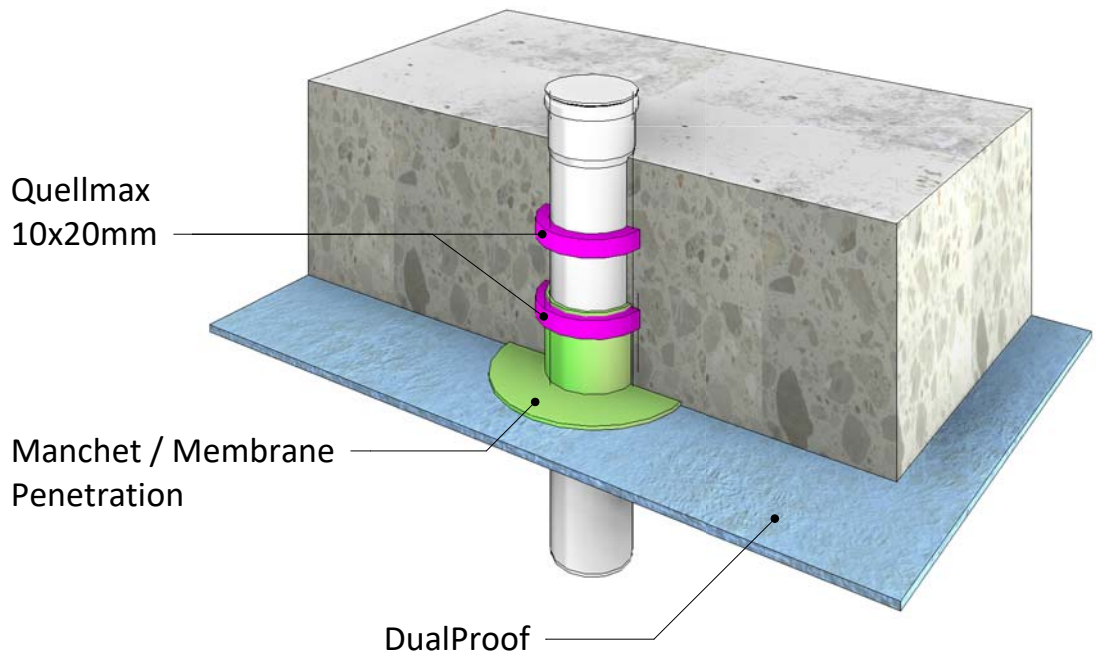

Project:

Title: **6 Pipe Penetration Floor Slab**

Clients:

Date:

Drawing by TE

BPA © 02/2018

## 7 Steel Pile

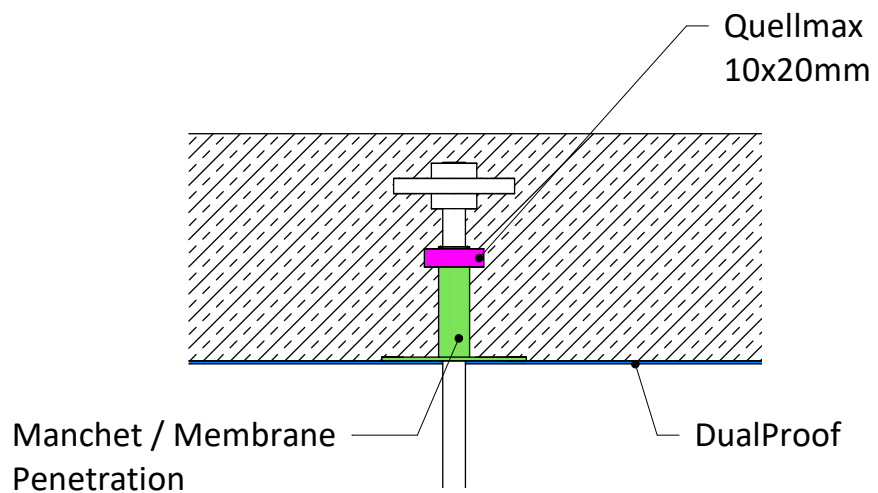
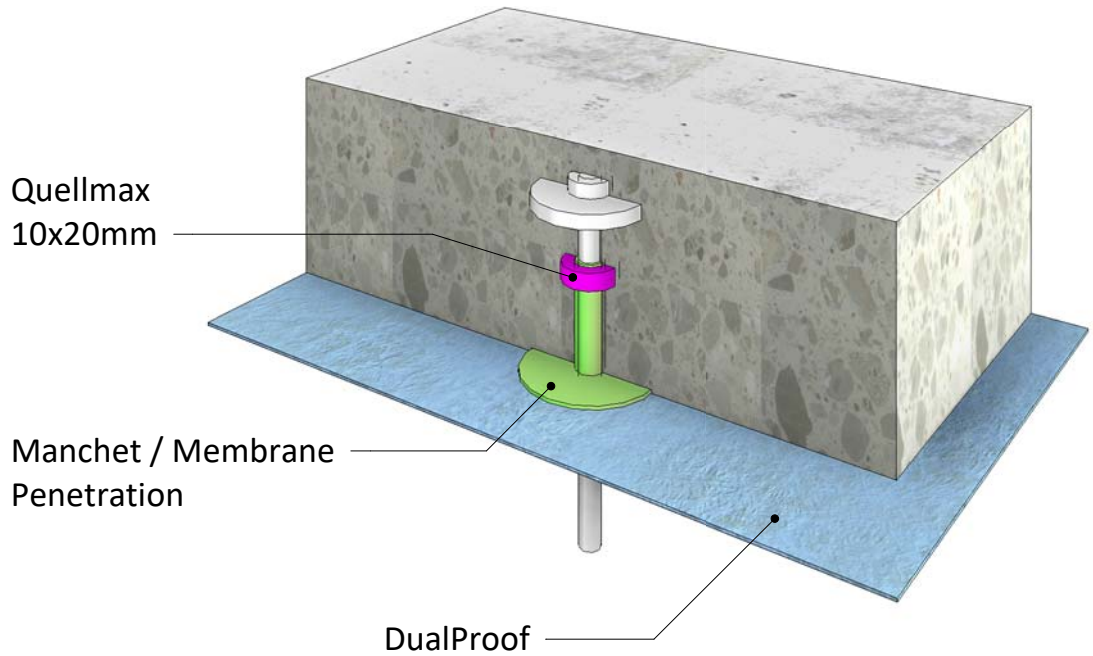

Project:

Title: **7 Steel Pile**

Clients:

Date:

Drawing by TE

BPA © 02/2018

## 8a Blind side Waterproofing Concrete Pile

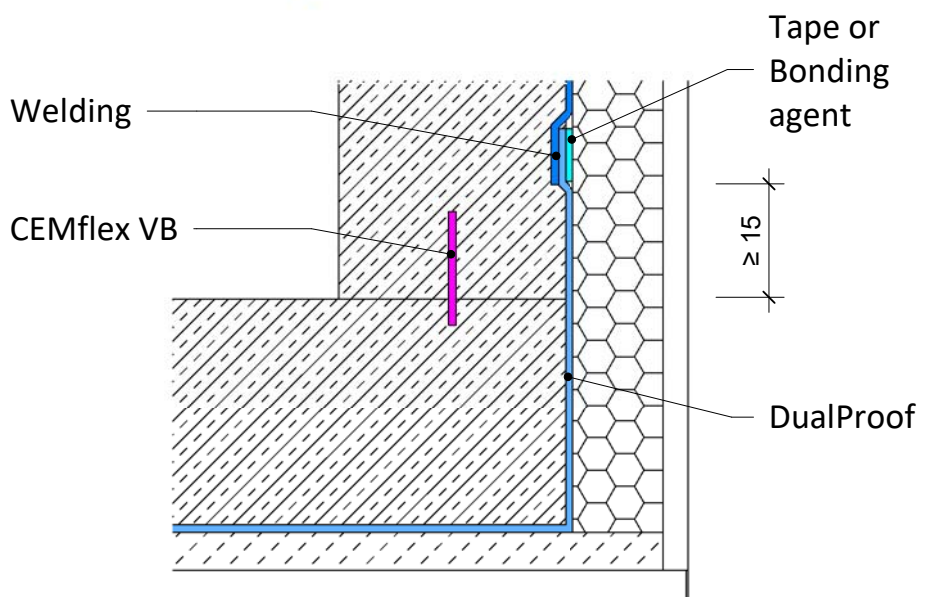
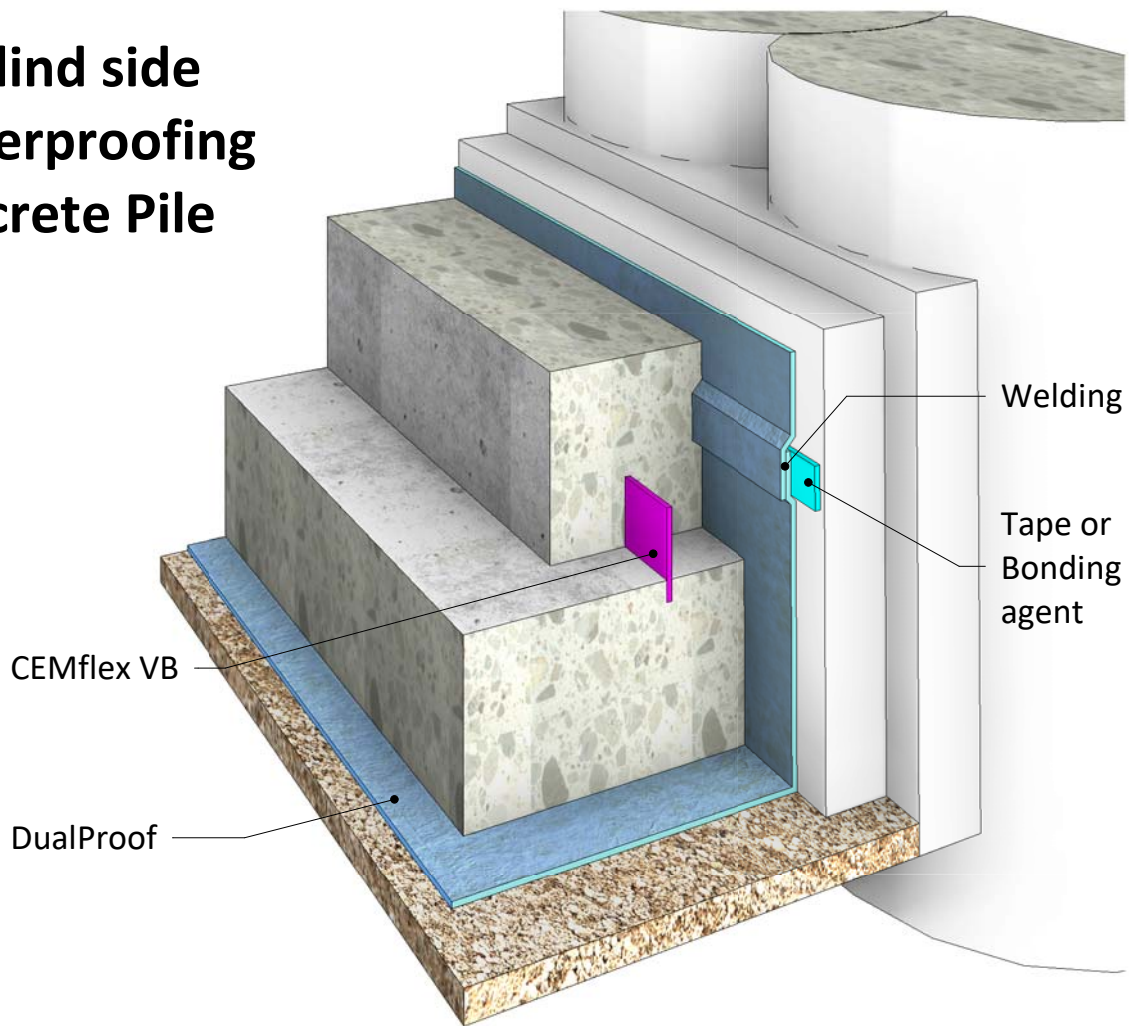

Project:

Title: **8a Blind side Waterproofing Concrete Pile**

Clients:

Date:

Drawing by TE

BPA © 02/2018

## 8b Blind side Waterproofing Sheet Pile

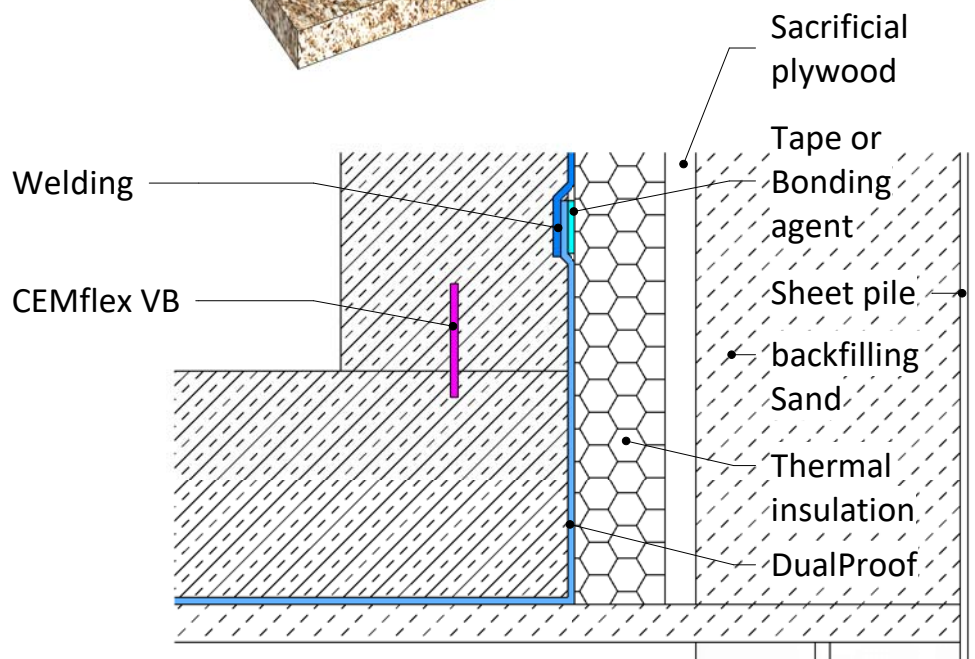
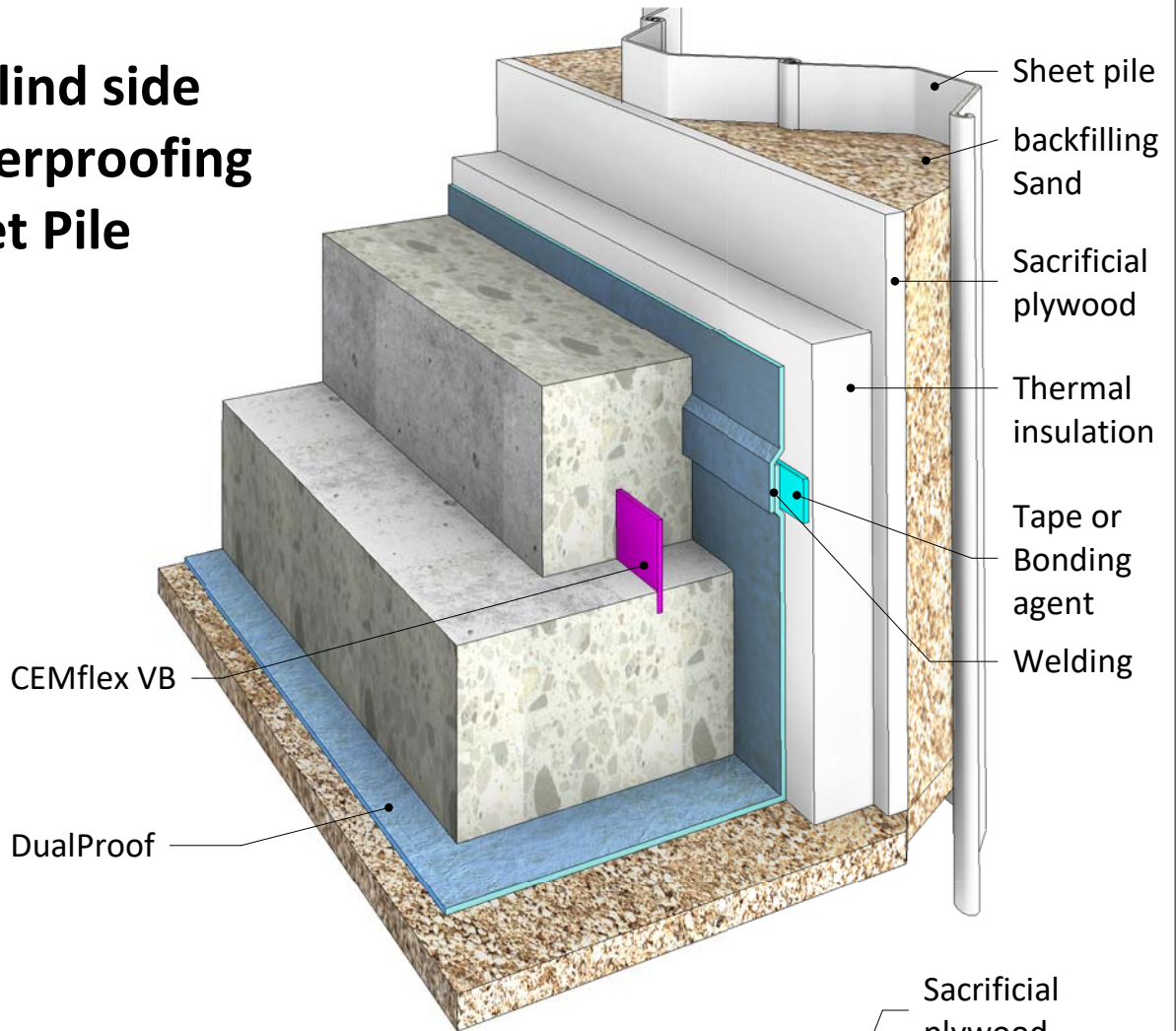

Project:

Title: **8b Blind side Waterproofing Sheet Pile**

Clients:

Date:

Drawing by TE

BPA © 02/2018